

Klimatizacijski uređaj

Kratki vodič

AR**TXHZ***

- Hvala što ste kupili klimatizacijski uređaj Samsung.
- Prije upravljanja jedinicom pažljivo pročitajte ovaj priručnik i čuvajte ga za buduću upotrebu.



SAMSUNG

Detaljan korisnički priručnik

Provjera na web-mjestu

- KORAK1.** Provjerite naziv modela.
- KORAK2.** Idite na web-mjesto Samsung (<http://www.samsung.com>) ili pročitatite QR kod.



- KORAK3.** Pretražite i provjerite Korisnički priručnik. PODRŠKA > Priručnici i preuzimanja > Pretraži model

Provjera u servisnom centru

- KORAK1.** Provjerite naziv modela.
- KORAK2.** Obratite se servisnom centru.
- KORAK3.** Zatražite korisnički priručnik svojeg modela proizvođača.

Pregled unutarnje jedinice

Izgled stvarnog proizvoda možda će se neznatno razlikovati od slike u nastavku.

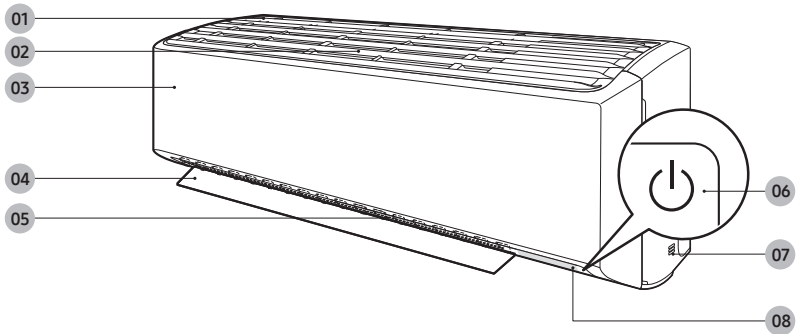

- 01 Ulaz zraka
- 02 Zračni filter
- 03 Sprednja plošča
- 04 Krilce za protok zraka (gore i dolje)
- 05 Krilce za protok zraka (lijevo i desno)
- 06 Gumb napajanja / prijemnik daljinskog upravljača
- 07 Senzor sobne temperature
- 08 Zaslون

Zaslون

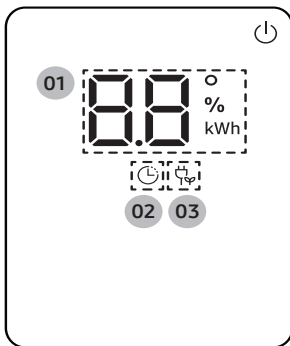

- 01 Pokazatelj temperature (brojčani)
Pokazatelj resetiranja filtra (F)
Pokazatelj funkcije automatskog čišćenja (C)
Pokazatelj funkcije odmrzavanja (dF)
- 02 Pokazatelj brojača vremena
Pokazatelj good'sleep
- 03 Eco pokazatelj

Rukovanje klimatizacijskim uređajem

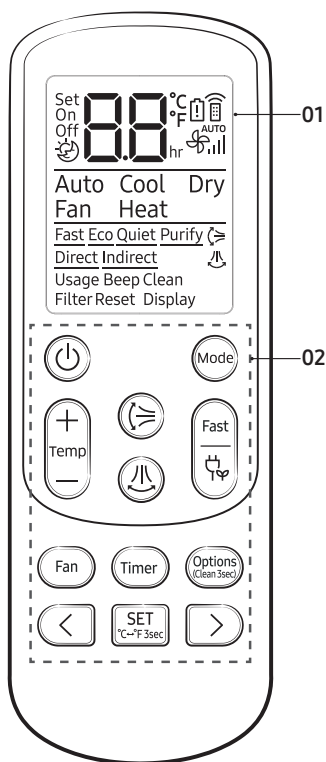

Funkcije i gumbi

Funkcija	Gumb i odabir	Zaslon
Napajanje uključeno/isključeno		
Auto	► ► Odaberite Auto.	Auto
Cool	► ► Odaberite Cool.	Cool
Dry	► ► Odaberite Dry.	Dry
Fan	► ► Odaberite Fan.	Fan
Heat	► ► Odaberite Heat.	Heat
Fast	U načinu rada Cool ili Heat ►	Fast
Quiet	U načinu rada Cool ili Heat ► ► ► ► odaberite Quiet. ►	Quiet
Beep	► ► ► Odaberite Beep. ►	Beep
Osvjetljavanje zaslona	► ► ► Odaberite Display. ►	Display

01 Zaslon

02 Gumb

NAPOMENA

- Iako se na zaslonu daljinskog upravljača prikazuje Vodoravni protok zraka () Purify, Usage, Direct, Indirect na ovom modelu to nije dostupno.
- Značajke se mogu razlikovati ovisno o modelima.

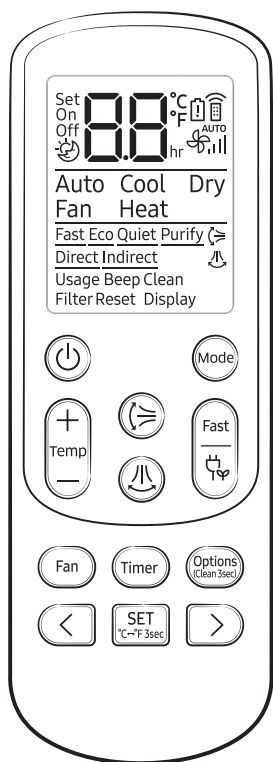

Funkcija	Gumb i odabir	Zaslon
Eco	U načinu rada Cool ili Heat ►	Eco
Vrijeme uključivanja/isključivanja	Timer ► Odaberite On ili Off ► (Postavite trajanje.) ► 	On Off
good'sleep	U načinu rada Cool ili Heat ► Timer (Odaberite) ► (Postavite trajanje.) ► 	

Čišćenje

Funkcija Automatsko čišćenje

Upotrijebite funkciju automatskog čišćenja ako unutarnja jedinica proizvodi neugodne mirise.

Aktivacija funkcije automatskog čišćenja

Kako biste aktivirali Automatsko čišćenje, držite pritisnutim gumb  (Options) najmanje 3 sekunde. Zaslom unutrašnje jedinice prikazuje:

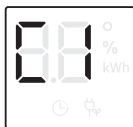

Otkazivanje funkcije automatskog čišćenja

Kako biste otkazali Automatsko čišćenje dok je u radu, slijedite postupak u nastavku:



▶ Pritisnite i zadržite 3 sekunde ili više.

Deaktivacija funkcije automatskog čišćenja

Kako biste deaktivirali Automatsko čišćenje, slijedite postupak u nastavku dok klimatizacijski uređaj radi ili je isključen:



▶ Odaberite Clean. ▶



Čišćenje filtra

Očistite filtar zraka svaka dva tjedna ili kada se na zaslonu unutarnje jedinice pojavi  (podsjetnik za čišćenje filtra). Vrijeme između čišćenja možda će se razlikovati, ovisno o upotrebi i okolnim uvjetima.

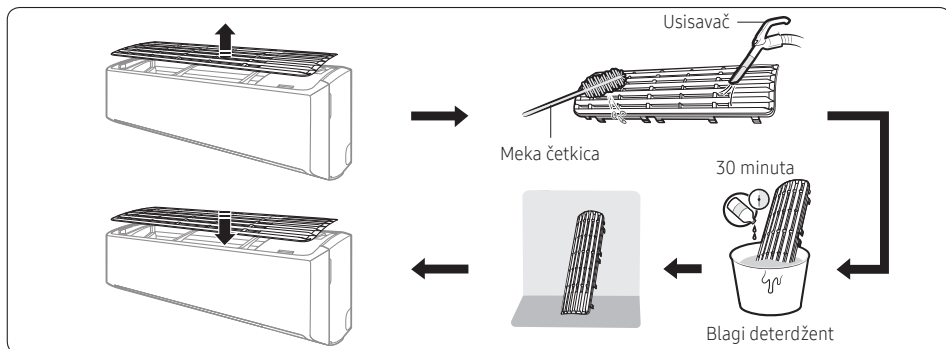

-
- 1 Gurnite filtar s jedinice.
 - 2 Upotrijebite mekanu četku ili usisivač kako biste uklonili prašinu ili ostatke na filtru.
 - 3 Namočite filtar u otopini vode i blagog deterdženta 30 minuta.
 - 4 Isperite filtar i ostavite ga da se osuši na zraku u dobro prozračenom području koje nije pod izravnom sunčevom svjetlošću.
 - 5 Ponovno postavite filtar.
 - 6 Ponovno postavite podsjetnik za čišćenje filtra:



PITANJA ILI KOMENTARI?

DRŽAVA	NAZOVITE	ILI NAS POSJETITE NA MREŽI NA
UK	0330 SAMSUNG (7267864)	www.samsung.com/uk/support
IRELAND (EIRE)	0818 717100	www.samsung.com/ie/support
GERMANY	06196 77 555 77	www.samsung.com/de/support
FRANCE	01 48 63 00 00	www.samsung.com/fr/support
ITALIA	800-SAMSUNG (800.7267864)	www.samsung.com/it/support
SPAIN	91 175 00 15	www.samsung.com/es/support
PORTUGAL	808 207 267	www.samsung.com/pt/support
LUXEMBURG	261 03 710	www.samsung.com/be_fr/support
NETHERLANDS	088 90 90 100	www.samsung.com/nl/support
BELGIUM	02-201-24-18	www.samsung.com/be/support (Dutch) www.samsung.com/be_fr/support (French)
NORWAY	21629099	www.samsung.com/no/support
DENMARK	707 019 70	www.samsung.com/dk/support
FINLAND	030-6227 515	www.samsung.com/fi/support
SWEDEN	0771 726 786	www.samsung.com/se/support
POLAND	801-172-678* lub +48 22 607-93-33* Specjalistyczna infolinia do obsługi zapytań dotyczących telefonów komórkowych: 801-672-678* * (opłata według taryfy operatora)	http://www.samsung.com/pl/support/
HUNGARY	0680SAMSUNG (0680-726-7864)	www.samsung.com/hu/support
AUSTRIA	0800 72 67 864 (0800-SAMSUNG)	www.samsung.com/at/support
SWITZERLAND	0800 726 786 (0800-SAMSUNG)	www.samsung.com/ch/support (German) www.samsung.com/ch_fr/support (French)
CZECH	800 - SAMSUNG (800-726786)	www.samsung.com/cz/support
SLOVAKIA	0800 - SAMSUNG (0800-726 786)	www.samsung.com/sk/support
CROATIA	072 726 786	www.samsung.com/hr/support
BOSNIA	055 233 999	www.samsung.com/support
North Macedonia	023 207 777	www.samsung.com/mk/support
MONTENEGRO	020 405 888	www.samsung.com/support
SLOVENIA	080 697 267 (brezplačna številka)	www.samsung.com/si/support
SERBIA	011 321 6899	www.samsung.com/rs/support
ALBANIA	045 620 202	www.samsung.com/al/support
BULGARIA	*3000 Цена на един градски разговор 0800 111 31 Безплатен за всички оператори	www.samsung.com/bg/support
ROMANIA	*8000 (apel in retea) 08008-726-78-64 (08008-SAMSUNG) Apel GRATUIT Atenție: Dacă efectuați apelul din rețeaua Digi (RCS/RDS), vă rugăm să ne contactați formând numărul. Te lverde fără ultimele două cifre, astfel: 0800872678.	www.samsung.com/ro/support
CYPRUS	8009 4000 only from landline, toll free	www.samsung.com/gr/support
GREECE	80111-SAMSUNG (80111 726 7864) only from land line (+30) 210 6897691 from mobile and land line	
LITHUANIA	8-800-77777	www.samsung.com/lt/support
LATVIA	8000-7267	www.samsung.com/lv/support
ESTONIA	800-7267	www.samsung.com/ee/support



Ovaj je uređaj napunjen sredstvom R-32.